

ASIN AQUA[®] Oxygen VS

EN

2021

POWER OF SYNERGIE
for crystal clear pool water without chlorine



**INTEGRATED
VS PUMP
CONTROL**



General safety information

This user manual contains basic information that should be observed during assembly, start-up, operation, and maintenance. Therefore, this user manual must be read by installers and operators prior to assembly and start-up, and must be accessible to every user of this unit. Additionally, all further safety information in this document absolutely must be observed. Read and follow all instructions. In order to minimize the danger of injury, do not allow children to use this product. Hazards from non-compliance with safety information. Non-compliance with safety information can result in hazards to persons, the environment, and the equipment. Non-compliance with safety information will result in a forfeit of any potential right to damage compensation.

Insufficient personnel qualification

Hazards in the event of insufficiently qualified personnel, potential consequence: Injury, heavy material damage.

- The system operator must ensure compliance with the required qualification level.
- Any and all work may only be performed by correspondingly qualified personnel.
- Access to the system must be prevented for insufficiently qualified persons, e.g. via access codes and passwords.

Potential overdosing of chemical agents

Despite ASIN Aqua® comprehensive safety functions, it is possible that a probe failure and other errors could lead to an overdosing of chemical agents. Potential consequence: Injury, heavy material damage.

- Design your installation such that uncontrolled dosage is not possible in the event of a probe failure or other errors, and/or such that uncontrolled dosage is recognized and halted before damage is incurred.
- Uncontrolled overdose of chemicals can cause harm to health and property. Even though the device contains a number of security elements can not be ruled out that in case of failure of the measuring probes, or the whole device may result in overdose of chemical agents. Install the equipment so that uncontrolled overdose of chemicals was not possible and that uncontrolled overdose has been detected in time before causing any harm. It is necessary to use chemicals in such quantities that an overdose will not cause dangerous concentration of chemical agents. Do not use chemicals in too large packages or with too high concentration.

Gaseous chlorine produced from dosing in standing water if dosing outputs are not closed via the filter pump

If the flow switch is stuck or experiences another error, there is a risk of dosing into standing water. Poisonous chlorine gas can be yielded when sodium hypochlorite and pH minus come together.

Non compliance with informational text

There is a great deal of informational text indicating hazards and their avoidance. Not observing informational text may lead to hazards. Potential consequence: gravest degree of injury, heavy material damage.

- Read all informational text carefully.
- Cancel the process if you are unable to exclude all potential hazards.

Use of new functions

Because of the continued development, a ASIN Aqua® unit may contain functions, which are not completely described in this version of the user manual. The use of such new or extended functions without a profound and secure understanding by the operator may result in malfunctions and severe problems. Potential consequence: Injury, heavy material damage.

- Make sure to get a profound and secure understanding of a function and relevant boundary conditions, before you start to use it.
- Check for an updated version of the user manual or additional documentation available for the relevant functions.
- Make use of the integrated help function of the ASIN Aqua® to get detailed information on functions and their parameter settings.
- In case it should not be possible to get a profound and secure understanding of a function based on the available documentation, do not use this function.

Overdosing if pH value is wrong

If disinfection is enabled before the pH value is stable in the ideal range of 7.0 to 7.4, then it may lead to heavy overdosing of chlorine or bromine. Potential consequence: Injury, heavy material damage.

- Do not start disinfection with chlorine until the pH value is stable in the ideal range between 7.0 and 7.4.

Conditions before using

Make sure you have a newest and updated version of the user manual and other documentation for all functions of the unit. Use and read the integrated help features. In case of not understanding the information about certain features of the unit, do not use these features.

Handling chemicals for pool water treatment

The chemicals used with the ASIN Aqua must be handled in a safe manner to prevent damage or personal harm. Aseko recommends you always use personal protective safety equipment when handling the pH and chlorine agents. Refer to the Materials Safety Data Sheet (MSDS).

WARNING: Never mix the pH agent with the chlorine agent. When carrying out maintenance on the clear plastic tubes or valves always rinse with clean water to prevent mixing of the pH and chlorine agents.



What do you receive in your box

Device
ASIN AQUA Oxygen

Probe housing 2 pcs
#12013

Electronic
flowmeter
with filter
#12106



Water thermometer with
housing #13192



Peristaltic pumps
#12093

Long Life pH Probe #12012



Coagulation mixer



Water valves 2 pcs #12006



Injection valve 4 pcs #12005



Suction tube weight 4 pcs #12023



PE Tube 1/4" (6.35 mm)
transparent 15m #12008



Wrench socket for
probes #13046



Dowels
and screws



Optional accessories

Externes Touch Display
#12048



Pressure-type level sensor
#12086



Air thermometer
#13192

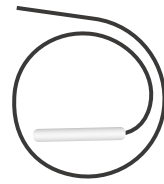

Inserting DN50 plug
1/4" threaded #12134



pH 7.00 Buffer #12065



Aseko original chemicals

Volume 20 l

OXY PURE #13038



pH MINUS #12130



pH PLUS #12120



ALGICID #12156



FLOC+C #12139



Volume 5 l

OXY PURE #13039



pH MINUS #12131



ALGICID #12157



FLOC+C #12138



Bottle 1 kg

SUPER CHLOR # 13120



Package 10 kg

BALANCER #13039



MAGNESIUM #13039





MAX POOL VOLUME
250 m³

ASIN AQUA Oxygen

POWER OF SYNERGY

for crystal-clear and chlorine-free water

The principle is above all based on perfect removing of all the impurities as well as larger bacteria by filtering. It is due to a unique mixture of coagulant and flocculant FLOC+C, which after having been sprayed in ZPM (coagulation mixer) shall gather even the smallest impurities to create larger flocules that shall subsequently be perfectly removed by the special AFM (Activated Filter Media). Thanks to the perfect mechanical treatment of water, it is sufficient to use minimum chemistry to keep water clean and safe. The basis for disinfection and removal of algae is the modern polymeric ALGICIDE being non-oxidative, hence very comfortable for skin. The OXYPURE preparation then only serves for oxidation of water and its sparkly appearance.

Pool water treatment

Well-balanced combination of all treatment aids will provide clean and crystal clear water

OXY Pure

Active oxygen for clean and crystal-clear water.

pH control

ASIN AQUA Oxygen makes it possible to dose **pH MINUS** or **pH PLUS**. Accurate measuring by pH probe combined with the system digital intelligence assures the required water quality.

ALGICIDE

The effective polymeric biocide protects water against algae, fungi, moulds and bacteria.

FLOC+C

FLOC+C contains flocculation and coagulation components. Its continual dosing improves filtration capability of removing even the smallest impurities.



Pool management functions

Filtration Time Control

Daily, automatic start of the filtering for individually preset periods.

Water Level - Refilling

Water level can be monitored by optional **level sensor**. System can be individually programmed to control up to four different water levels at your pool and switch the water refilling or waste water draining on/off (this requires an optional **Besgo** valve for automatic backwashing).

Filter Backwashing

The system can control the filter backwashing time interval (this requires an optional **Besgo** valve for automatic backwashing).

Smart Heating Control

The system is equipped by intelligent control of preset water temperature. It can switch and control the heating (electrical heating, gas heating, heat exchanger) by logic of integrated smart heating functions. The system must be equipped by optional **air thermometer**.

Freeze Protection

Unless you want to drain the pool for the winter season, this function can ensure protection of the pool water against freezing. The system must be equipped by optional **air thermometer**.

Control by External touch display

Some functions of ASIN AQUA Oxygen can be monitored and controlled by external touch display. System must be equipped by optional **External touch display**.

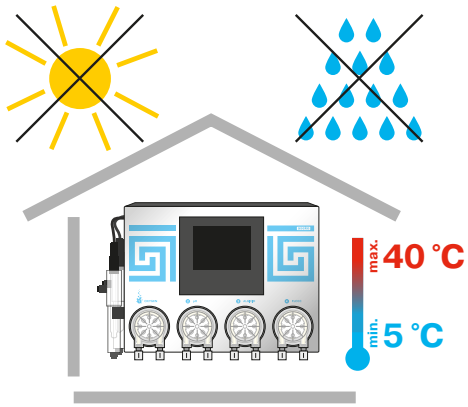

ASIN AQUA Oxygen Installation

ASIN AQUA Oxygen is to be wall mounted in dry and dust-free environment with temperature ranging from +5 °C to +40 °C. Install the mounting rail, which serves for attachment, to the wall. Select location so that free space at least 40 cm in all directions and height above floor at most 150 cm are provided. Drill three holes in the wall at the distance of 18.5 cm. Use screws supplied with ASIN AQUA Oxygen for attachment.

Use screws supplied with ASIN AQUA Oxygen for attachment.

WARNING: The location temperature should permanently be in the range from +5 °C to +40 °C.

Direct sunlight, high humidity and dust may lead to damage to ASIN AQUA Oxygen.

- Before installing, ensure that pool water is chemically clean and free of dirt.
- The maximum distance of injection valves from peristaltic pumps of ASIN AQUA Oxygen must not be greater than 8 m.
- Vertical distance between ASIN AQUA Oxygen and the bottom of containers must not exceed 2 m.

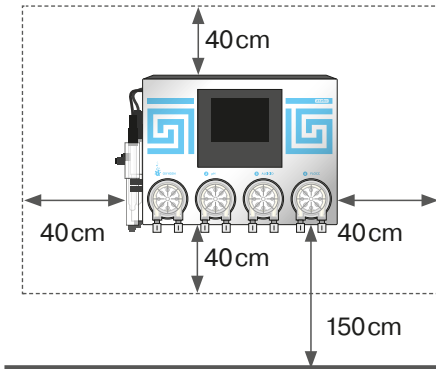

Mounting rail

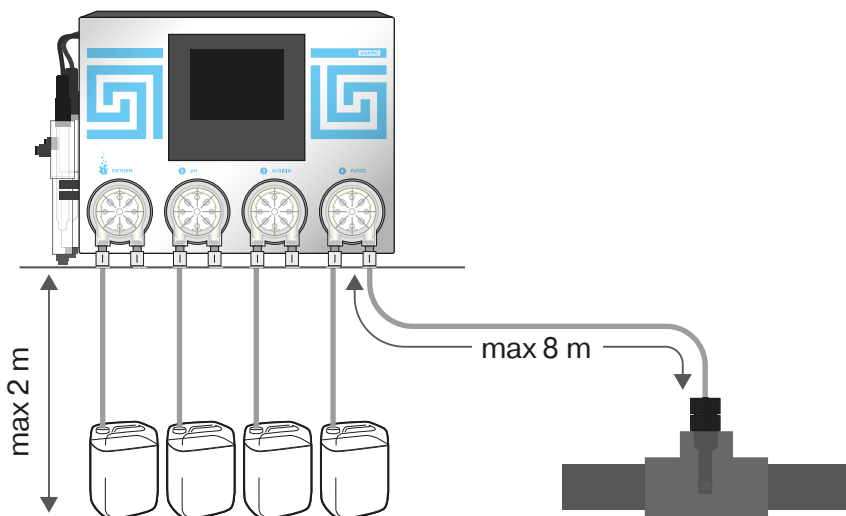
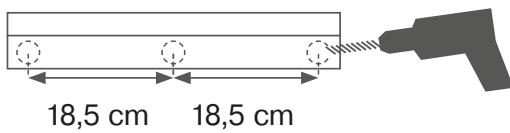

Installing the Probes

1. Carefully insert the probe into the housing.
2. Hand tighten or use the attached plastic wrench socket for probes.
3. Connect the connector and lock it by tightening a connector ring.

After the probe have been inserted, slightly tightened and connectors have been connected, ASIN AQUA Oxygen is ready for connection to the water system of your pool.

WARNING: Only hand tighten the probe or use the attached plastic wrench socket for probes. Do not use pliers or steel wrench.

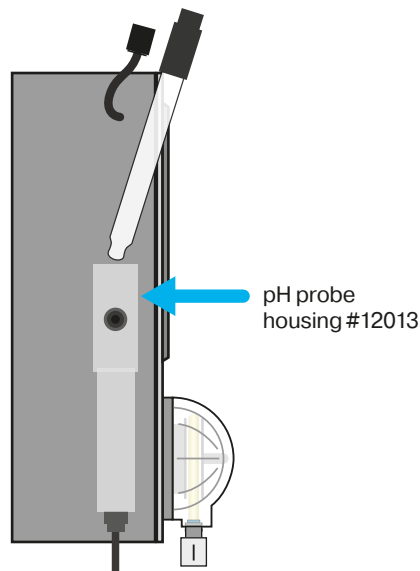

pH Long Life probe
#12012

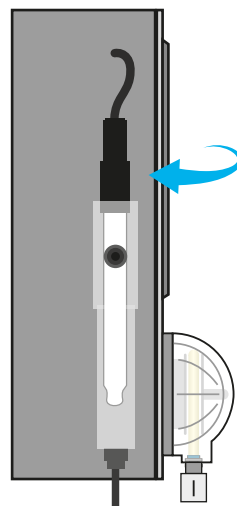

Wrench socket for
probes #13046



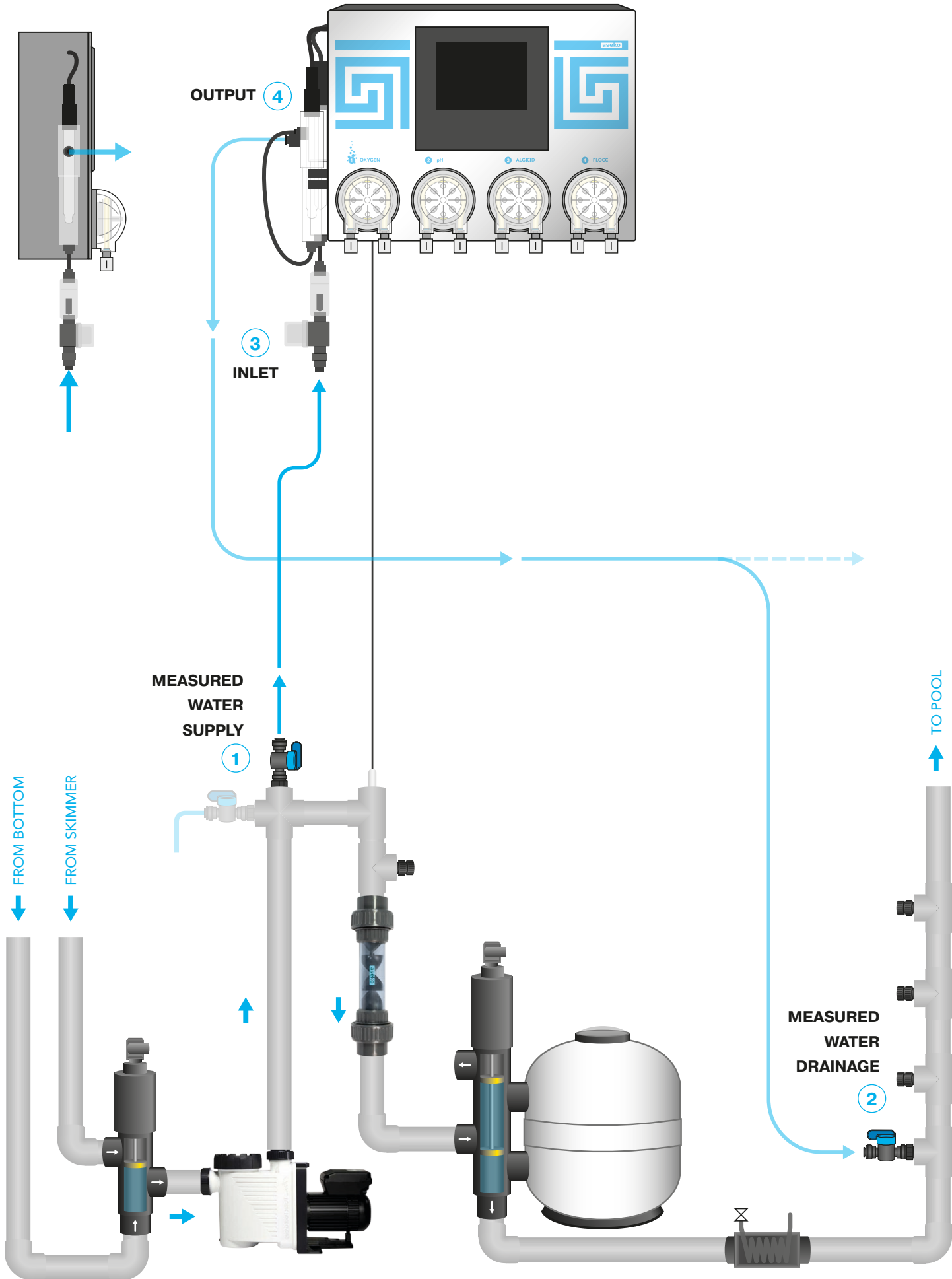

Pool Water Connection

The pool water to be measured must be brought to the ASIN AQUA probes.

We place the **shut-off valve** in the plug D = 50 with thread G1 / 4 " # 12134, glued to the T-piece. **Tighten by hand only. Do not use pliers or other tools.**

- 1 Connect the **MEASURED WATER SUPPLY** to the pipe **behind the pump, in front of the filter** and the coagulation mixer.
- 2 Connect the **MEASURED WATER DRAINAGE** to the pipe **behind the filter** and heating or into the overflow tank or skimmer.

Use to connect the measured water to your ASIN AQUA PE tube 1/4 "(6.35 mm) #12008, which is part of the delivery.

WARNING

To ensure that the joints are tight, cut the PE tube at an angle of 90°. Use special pliers # 13325 to cut plastic tubes. The cut must be clean and smooth. Do not use ordinary scissors or knives!

The measured water is easily connected to your ASIN AQUA using the **Speedfit** push-in fitting.

CONNECTION Push the connecting pipe into the Speedfit fitting and then pull on the hose to secure.

DISCONNECT push and hold the Speedfit round collet and pull out the connecting pipe.

- 3 **INLET** of the measured water to the ASIN AQUA Connect to the Speedfit fitting on the inlet filter.
- 4 **OUTPUT** of the measured water from ASIN AQUA connect to the Speedfit fitting on the probe well.

Once connected, your ASIN AQUA is ready to measure disinfectant content and pH value in your pool.

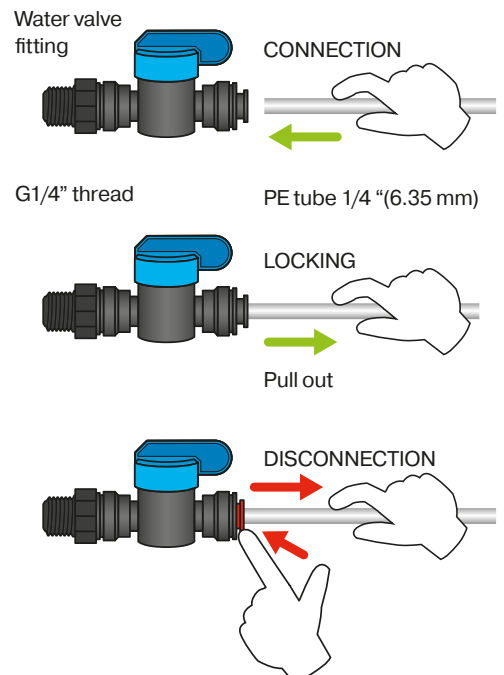
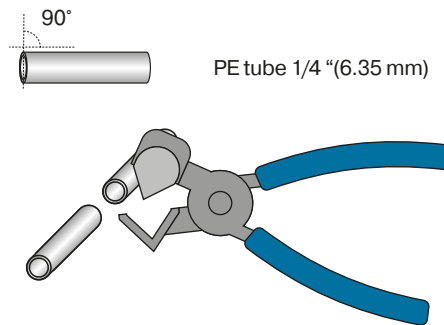
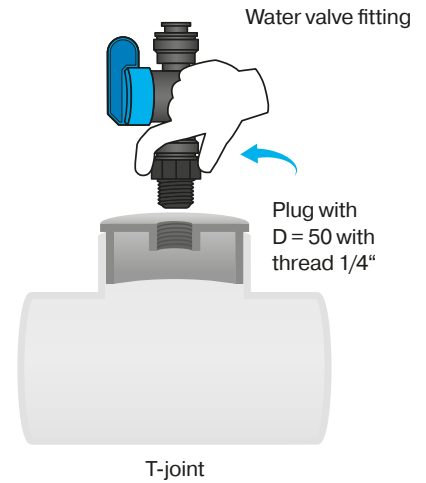

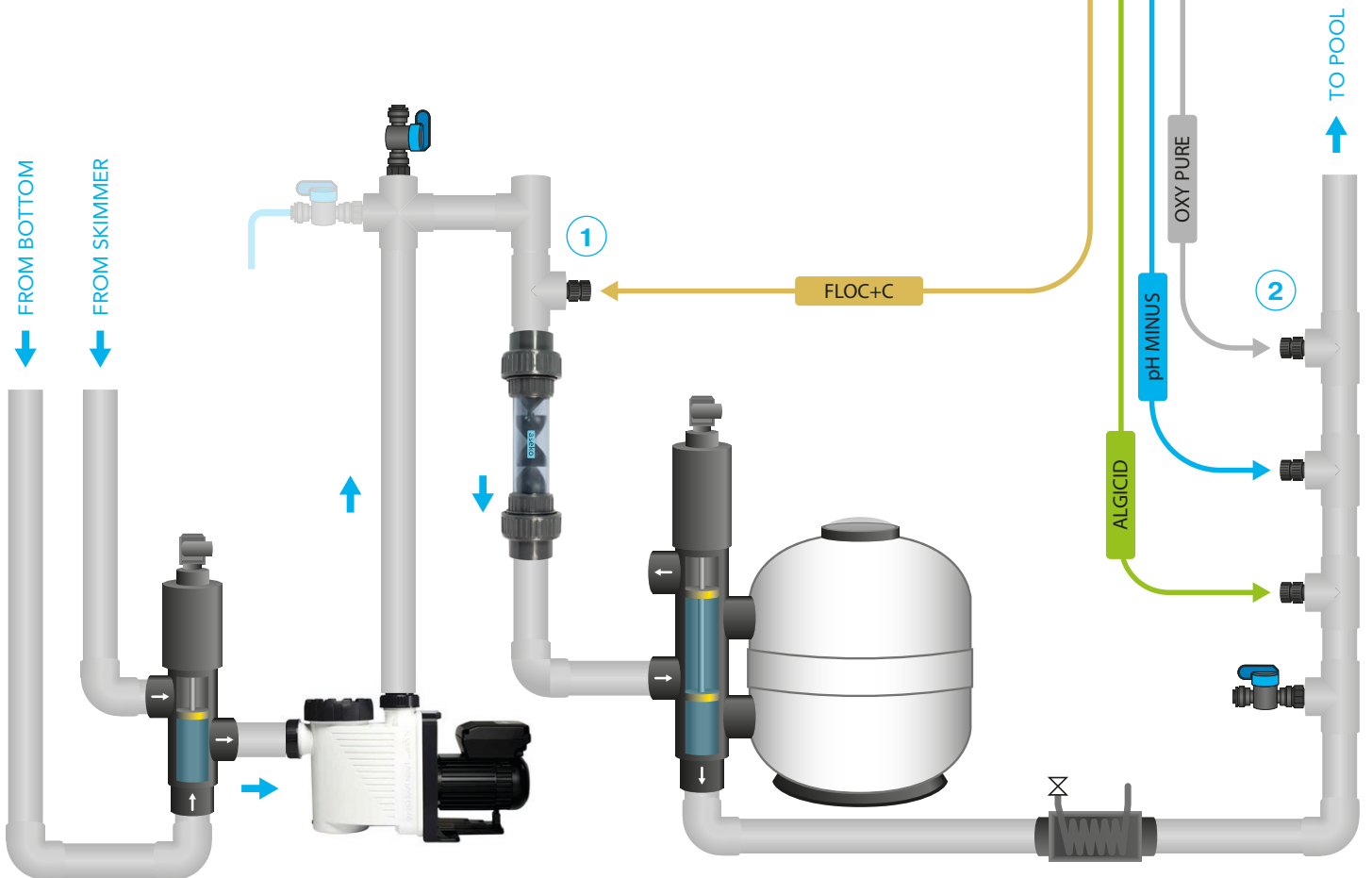
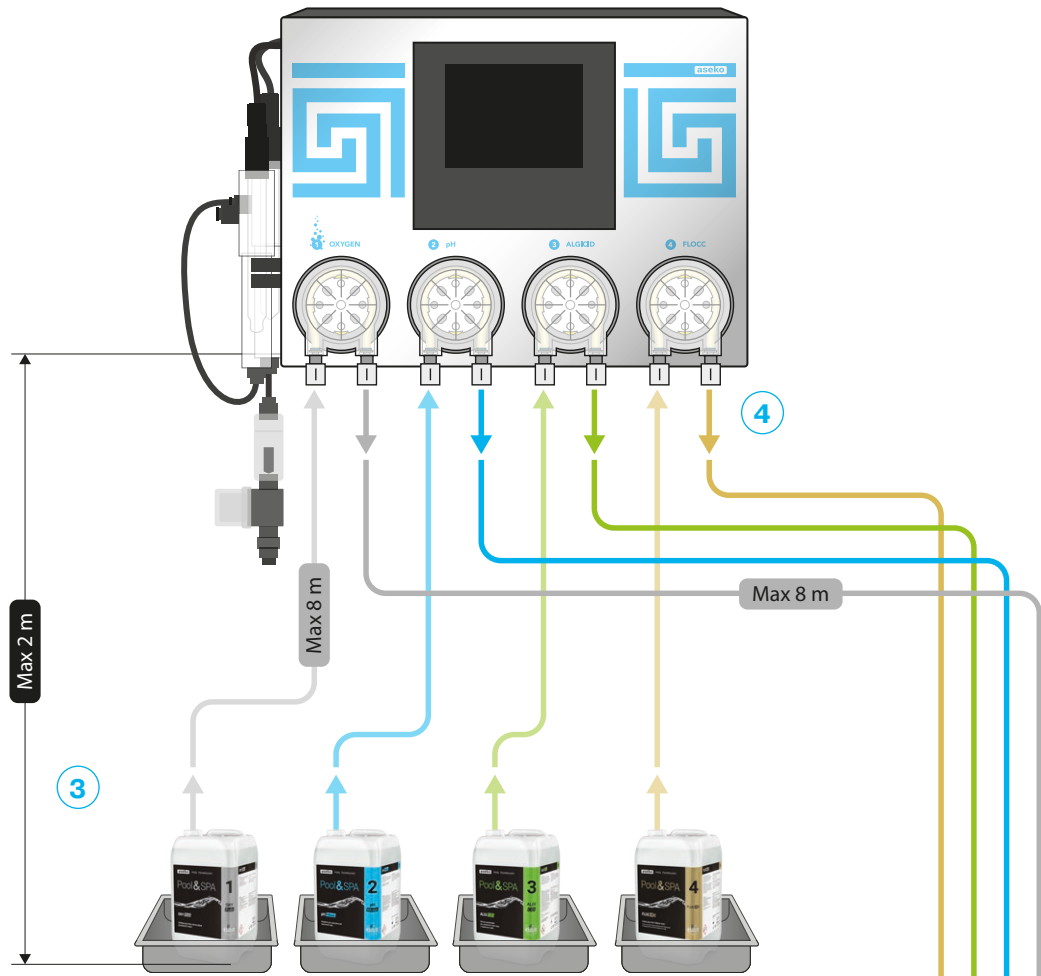

Pool Chemicals Connection

Screw the **injection valves** into the plug D = 50 with thread G1 / 4 " # 12134, glued to the T-piece. **Tighten by hand only. Do not use pliers or other tools.**

- 1 Connect the **FLOC+C INJECTION VALVE** to the pipe before the coagulation mixer and before the filter.
- 2 Connect the **ALGICIDE, pH, and OXY PURE INJECTION VALVE** to the pipe behind the filter and behind the drainage of the measured water. Connect injection valves in this order to prevent scale formation.

To connect reagents from cans to the ASIN AQUA and from the ASIN AQUA to the injection valve use PE Tube 1/4 "(6.35 mm) # 12008, which is part of the delivery.

WARNING

To ensure that the joints are tight, cut the PE tube at an angle of 90°. Use special pliers # 13325 to cut plastic tubes. The cut must be clean and smooth. Do not use ordinary scissors or knives!

- 3 **CANISTER CONNECTION** Drill 6.35 mm and 1 mm diameter holes in the canister cap. Pass the pipe through the cap so that it reaches to the bottom of the canister. Place the suction basket at the end of the pipe.
- 4 **PUMP CONNECTION** connect the suction of the pump on the left to the canister connect the pump discharge on the right to the injection valve.
- 5 **INJECTION VALVE CONNECTION** Pass the pipe through the nut, thread the pipe onto the injection valve and tighten the nut firmly by hand.

WARNING

NEVER CONNECT pH minus reagent to disinfection pump or disinfectant to pH pump! In the case of a cross-connection, after ten doses ASIN AQUA displays an error message. Repair the piping installation and then you can continue to operate your ASIN AQUA.

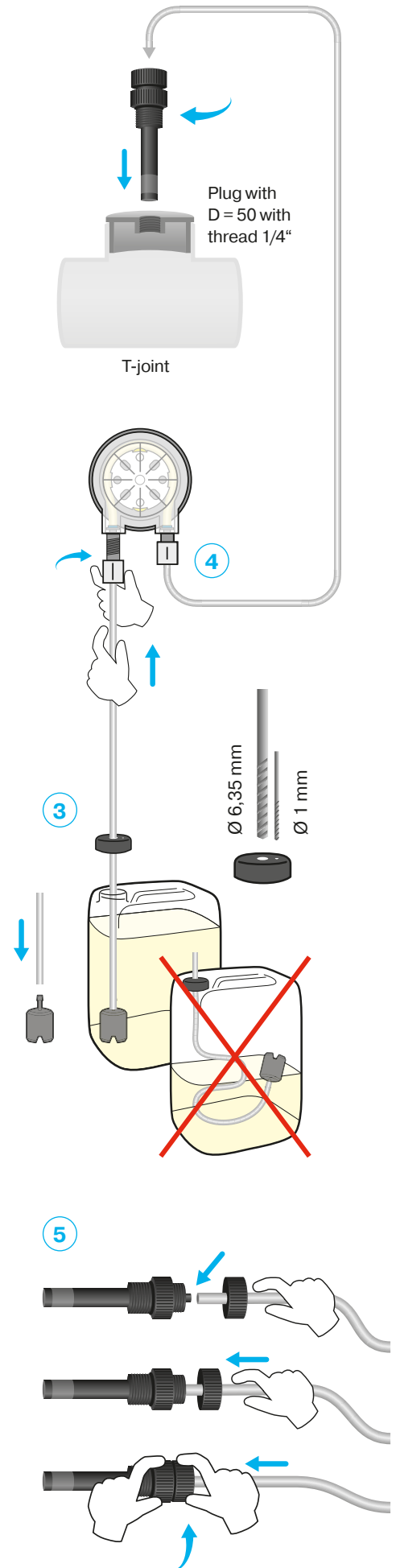

Accessories Connection

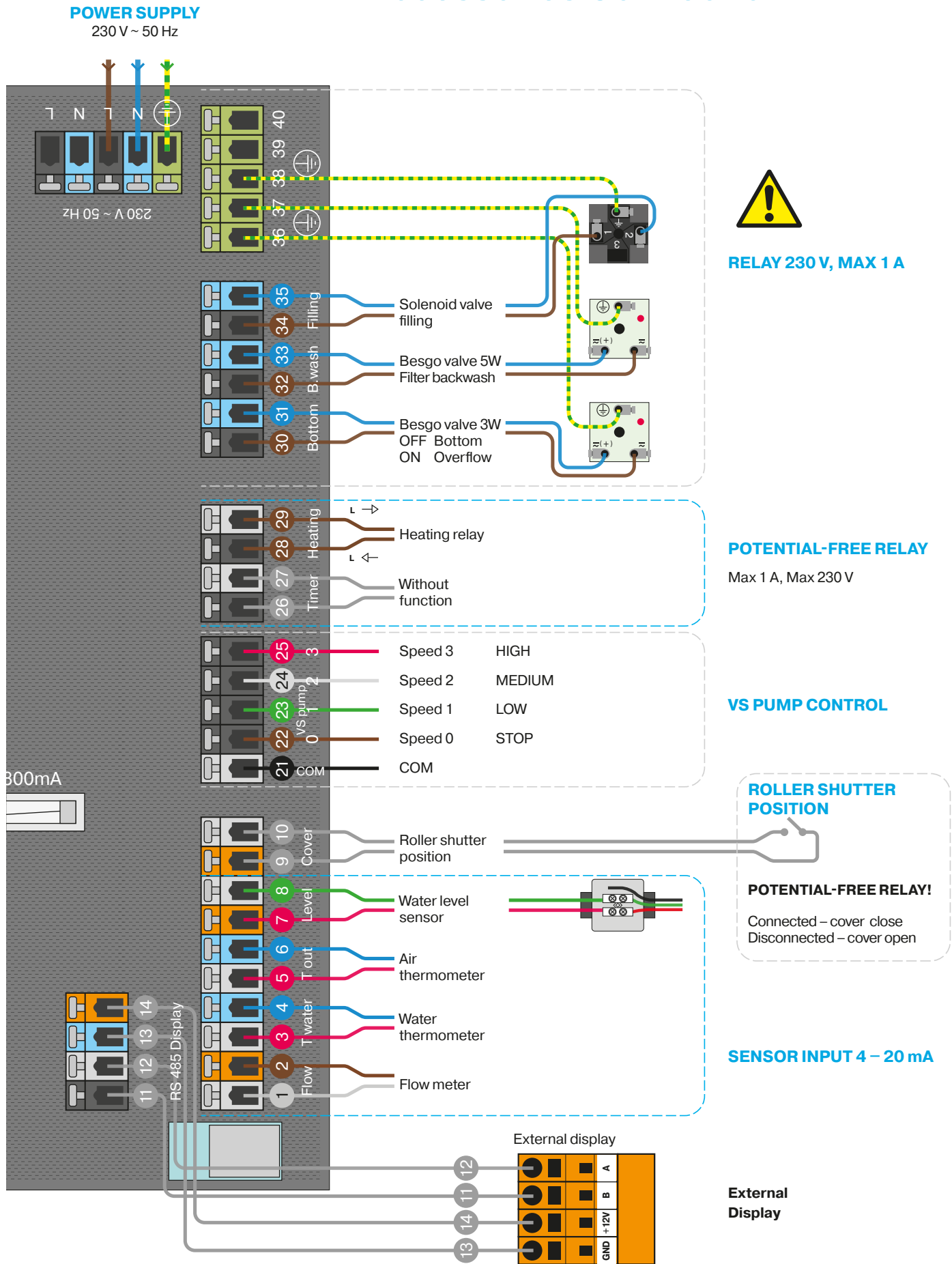

VS pump connection

WARNING

Always check the connection according to the current user manual of your pump manufacturer.

TYP A					TYP B					TYP C				
COM	S1	S2	S3	STOP	COM	S1	S2	S3	S4	COM	S1	S2	S3	STOP
n1	ON	OFF	OFF	OFF	n1	ON	OFF	OFF	OFF	n1	ON	OFF	OFF	OFF
n2	OFF	ON	OFF	OFF	n2	OFF	ON	OFF	OFF	n2	OFF	ON	OFF	OFF
n3	OFF	OFF	ON	OFF	n3	OFF	OFF	ON	OFF	n3	OFF	OFF	ON	OFF
S	OFF	OFF	OFF	ON	S	OFF	OFF	OFF	ON	S	ON	ON	ON	OFF

Speed (circled around S1 in TYP A)

Relay status (circled around S in TYP A)

TYP A

SPECK

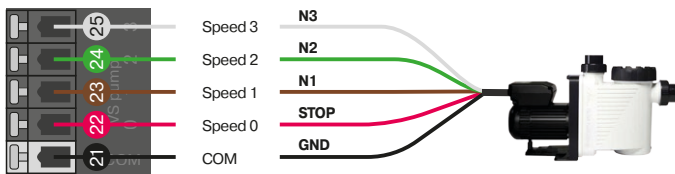

UWE EO PM

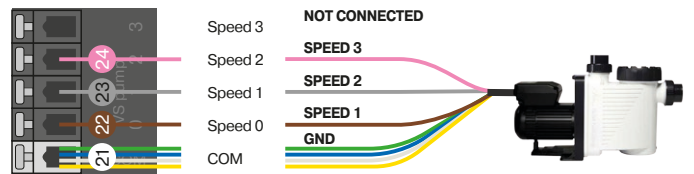

INVERTER POOL PUMP

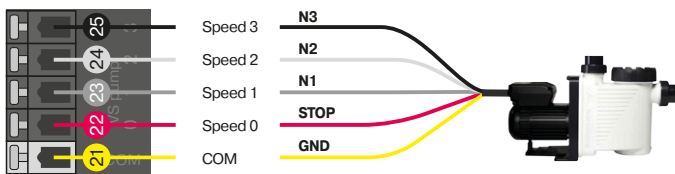

HAYWARD KS Evo VS

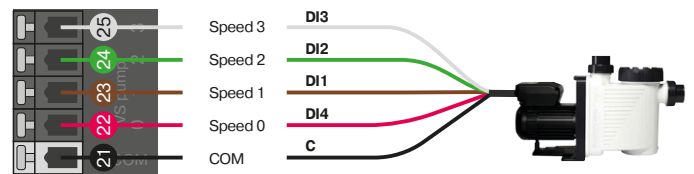

TYP B

PENTAIR

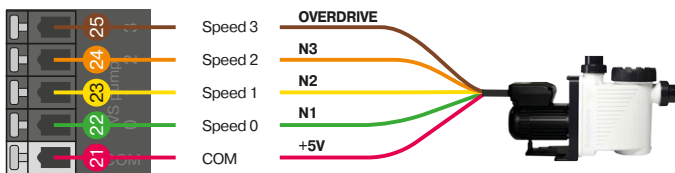

DAB E.SWIM - E.PRO

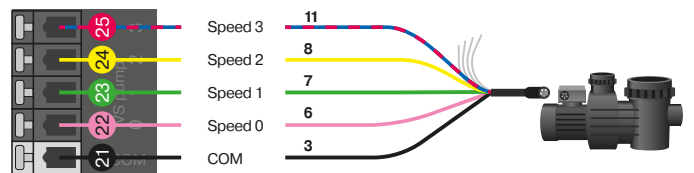

TYP C

HAYWARD (older type)

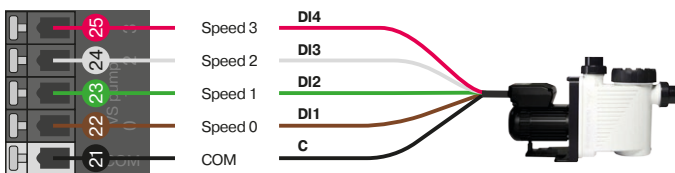



Installation must be protected by a residual current device (RCD).

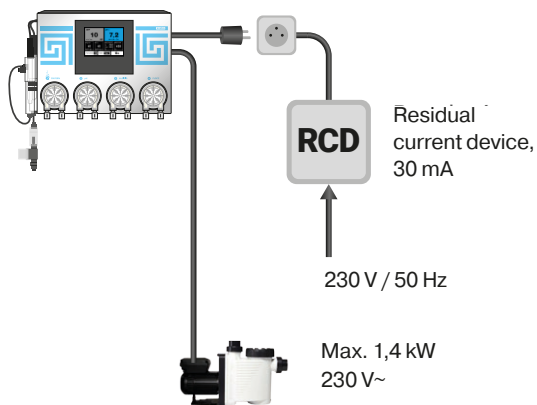

Power Supply

Connection to the mains:

1. Leave the mains switch in the off position.
2. Connect the filtering device to the ASIN AQUA Oxygen switched socket outlet (filtration power supply - max. 1.4 kW / 230 VAC).
3. Connect the 230 V / 50 Hz mains cable to ASIN AQUA Oxygen (on the right side). The mains socket outlet must be protected by a residual current device (RCD).
4. Change the mains switch over to the on position.

After Device has been switched on, the display will come on and the ASIN AQUA Oxygen starting screen will appear.

Disconnection from the mains:

1. Change the mains switch over to the off position.
2. Disconnect the ASIN AQUA Oxygen mains cable from the 230 V / 50 Hz socket outlet.
3. Disconnect the filtering unit mains cable from ASIN AQUA Oxygen.

WARNING: If Device is used in the manner different from that specified by the manufacturer, protection provided by Device may get damaged.

Power supply	230 V / 50 Hz
Power consumption	24 VA
Power consumption (including filter pump)	1449 VA
Max. input power of connected pump	1,4 kW / 230 V AC
Fuse	T800 mA; T160 mA; T6,3 A
Over-voltage category	II
Ingress protection	IP30
Operating temperature	+5 až +40 °C
Weight	6,7 kg
Installation	wall mounted
Relay output contacts	230 V / 1,4 kW
Discharge of dosing pumps	10 and 60 ml/min / max. 1bar
Measured water pressure	max. 1 bar (no underpressure required)
Dimensions	430 x 330 x 160 mm

Installation Test

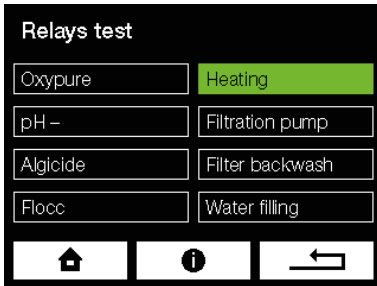

WARNING: Any obstacles, bubbles or leaks in the connecting tube will prevent ASIN AQUA Oxygen from correct operating. The clear plastic tube allows you to monitor flow of liquid to the injecting valves.

Before commencing the operation, test ASIN AQUA Oxygen installation. Most problems result from incorrectly performed installation.

Test

In the “Test of Outputs” menu, gradually start all the pumps and while they are running, check tightness of all the PE tube connections. Check the injecting valves for blockage and air bubbles in the PE tube.

DO NOT FORGET! Provide the testing run and stop of all accessories connected to ASIN AQUA Oxygen. At this step just test, do not dose the aids or provide the initial dose of chemicals!

Initial dose

In following steps.

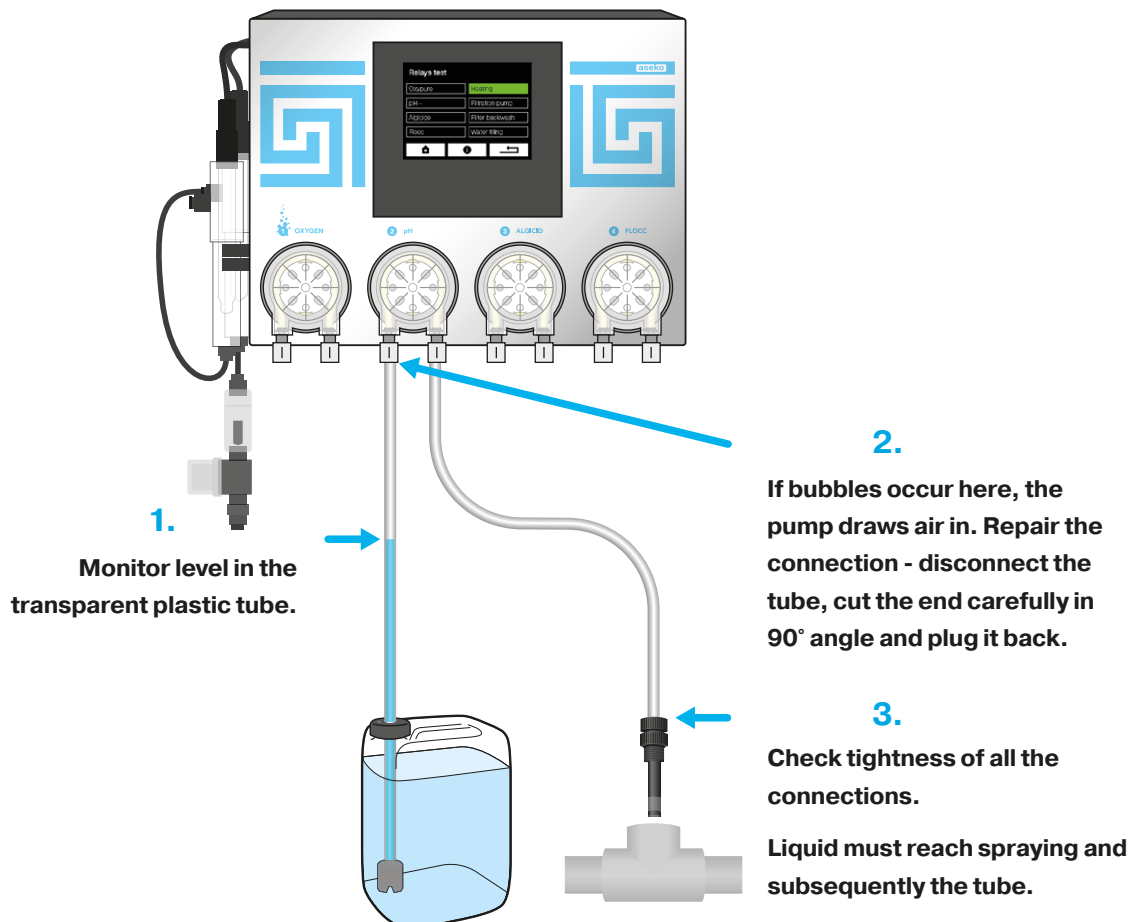

Touch screen description

Basic Screen

The basic screen display measured, required values and status information.

E.g. click on the **OXY** tab to enter the setting of the required OXY PURE value in pool water.

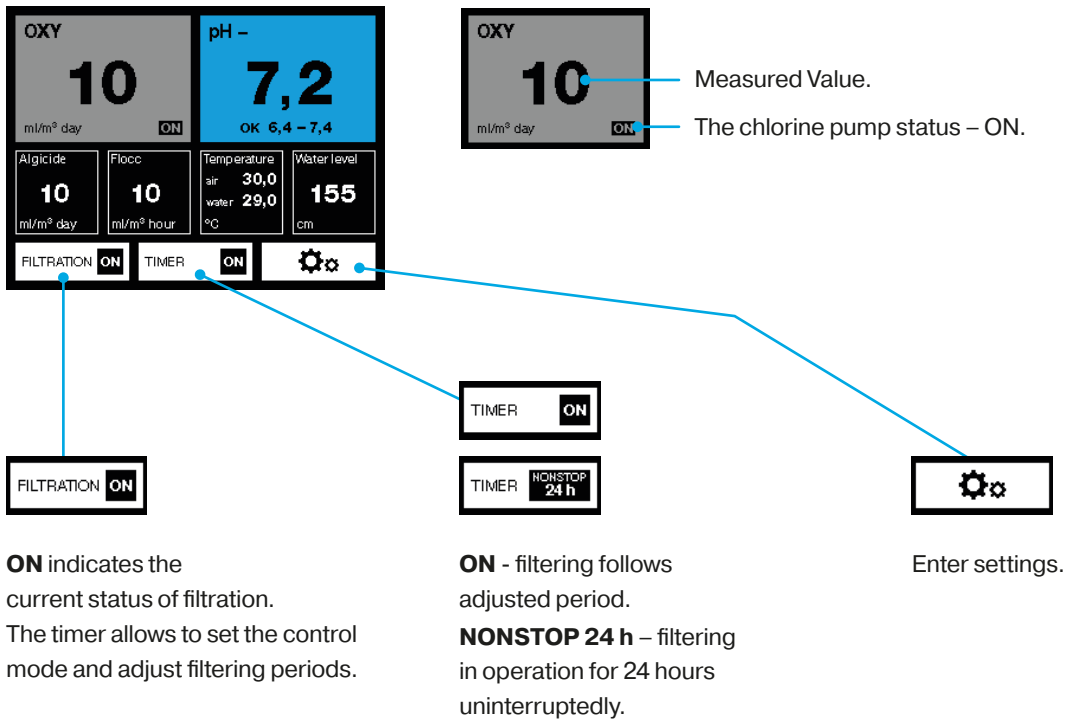

Manual control allows to:

switch filtration on/off

independently to preset filtering periods.

start filter washing independently to adjusted washing time.

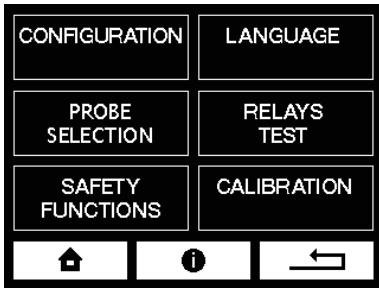

Settings



Back to the main screen.



Displays help/manual for the particular screen.



Back to the previous screen.

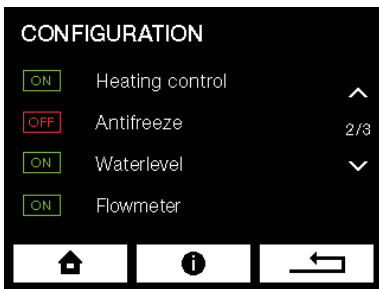

Movement through Menu



Movement in menu to the previous page.

Indicator of the current page and the total number of pages.

Movement in menu to the next page.



ON - function is switched on



OFF - function is switched off

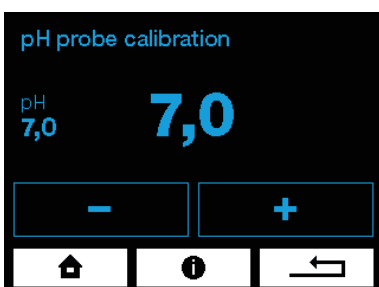

Value Settings



Reduces the value.



Increases the value.

Configuration

Date and Time

To ensure the correct function of timers, set the current date and time.

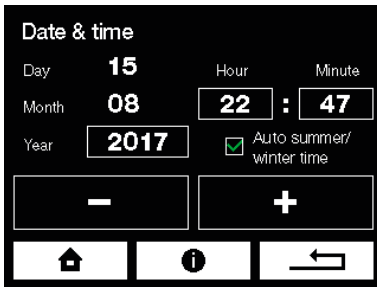

Pool Volume

To ensure the correct function of ASIN AQUA Oxygen, enter the correct volume of your pool. Calculate your pool volume in m³:

Length (L) times width (W) times depth (D) is volume (V) - (L × W × D = V).

Enter the value using + and - buttons.

WARNING: The pool volume has effect on the maximum safe dose, enter the correct value.

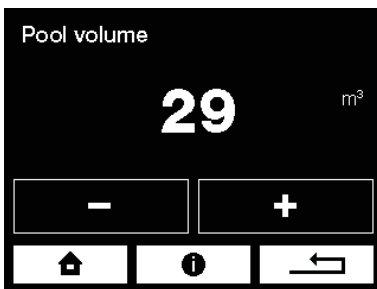

Filtration Timer

Filtration can be set to NONSTOP operation for 24 hours or to one, maximum to two time periods.

Variable Pump Control

ASIN AQUA Oxygen allows to control the SPECK or PENTAIR variable output circulating pumps. The pump runs at speed 2 in filtering periods, besides the preset filtering (when the standard pump is off) it runs at speed 1 (or can stay switched off according to your choice). In case of backwashing, the pump is running at speed 3.

Individual speeds 1, 2, 3 are adjusted directly on the pump according to the respective pump manual.



Automatic Filter Washing

Considering that the ASIN AQUA Oxygen technology is in particular based on the high efficiency of filtering and removing even the finest impurities, it is necessary to **wash the filter on a regular basis**. The automatic washing function ensures the filter washing on a regular basis in the preselected intervals.

To enable this function, it is necessary to use the automatic 5-way BESGO valve. Its moving is enabled by the relay switching on. When the relay switches on, the BESGO valve is enabled and moved to the required position by the action of pressure water or air. See the BESGO manual.

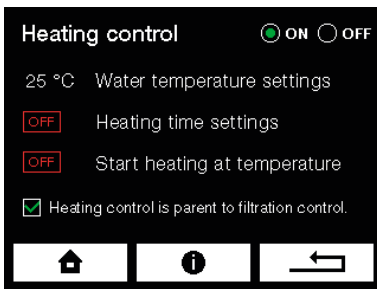

Heating Control

Water Temperature Measurement and Heating Control

The high-accuracy electronic thermometer is used to measure water temperature. This should be installed to the inlet pipe coming from the pool. Never mount it downstream of the heat exchanger. Significant distortion of temperature occurs. When temperature drops below the required value, the relay switches on your heat source (heat pump, electric heating, gas boiler circulating pump).

Smart Heating

Heating Control Function Takes Priority over Filtration Control

If you select the temperature control to take priority over the filtration timer, heating as well as the circulating pump will be in operation even after the adjusted filtering time has elapsed. The pump will stop only after the required temperature has been achieved.

Heating Time Adjustment

This function allows to adjust day time for which heating will be in operation. This is particularly useful for switching on the heat pumps that have a higher efficiency during the day when outdoor temperature is higher, eventually to eliminate the time when noise from heat pump disturbs you neighbor.

Heating at Outdoor Temperature (above or below)

This function allows to adjust outdoor air temperature at which or below which ASIN AQUA Oxygen starts heating. This function requires installation of the **outdoor air thermometer** #8953. This function is useful to control effectiveness of air heat pumps eventually to eliminate heating when you do not use the pool.

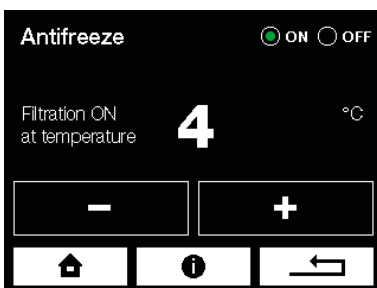

Freeze Protection

To enable this function is necessary to install **outdoor air thermometer** #8953.

- After the freeze protection has been enabled, ASIN AQUA Oxygen checks outdoor temperature. If outdoor temperature is lower than 0 °C, filtration is switched on to circulate the pool water. After 15 minutes will ASIN AQUA Oxygen measure temperature of the pool water.
- If the pool water temperature drops below the value set in the freeze protection menu (4°C), ASIN AQUA Oxygen will continue filtering and switch on the pool water heating. After the required freeze protection temperature has been reached, heating and filtering will stop.
- If outdoor temperature stay below zero, filtering will start in 6 hours again for 15 minutes in order to control water temperature.

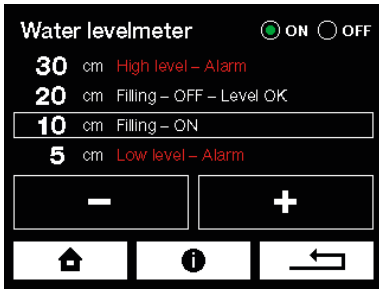

Level sensor - Level Monitoring and Automatic Refilling

Level measurement is performed by the **pressure-type level sensor**. This allows the very easy installation of the sensor by its inserting into the storage water reservoir or skimmer. Level is monitored at four heights that are easily entered in centimeters of water height.

Setting:

High level ALARM - too much water in overflow tank

After this level is reached, following actions may start:

1. If the automatic filter washing is enabled, one filter washing cycle starts and drains the waste water.
2. If the automatic filter washing is not enabled, the relay 17 switches on (filter washing) for the period of time until level is OK. The second circulating pump or automatic drain valve can be connected to this relay.

Refilling OFF - required level

Refilling stops

Refilling ON - level at which refilling starts

Refilling starts after if the water level stay permanently at least for 10 seconds below this value (in order to prevent oscillating)

Low level ALARM

Circulation (filtering) pump shuts off

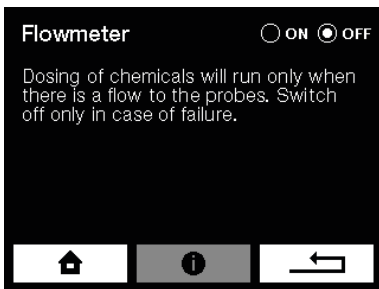
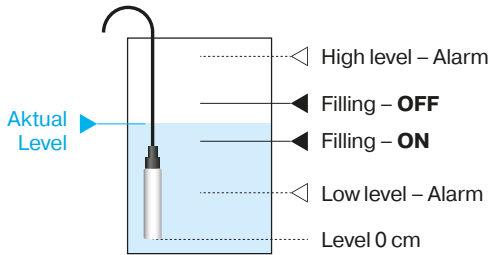

Flowmeter

The flowmeter detects flow of measured water. Dosing of chemicals will take action only if flow of measured water to probes is detected.

Wash the check flowmeter strainer on a regular basis.

Warning: Only switch off the flowmeter in case of a failure.

Delay

Delay time after dose is time for which ASIN AQUA Oxygen does not dose and wait for the dose response at the measuring water. At pools is average response time 4 to 10 min, at SPA 1 to 10 min.

Delay time after start (upon timer switching on) is time after start for which ASIN AQUA Oxygen does not take any action and it waits for stabilization of a signal from probes.

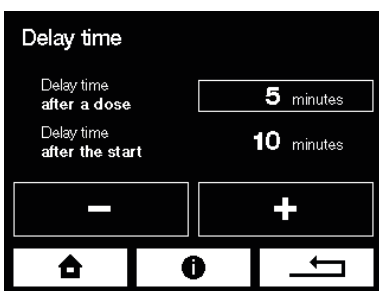

Concentration pH –

If you use the original ASEKO Pool & SPA chemicals keep the preadjusted values. In case of use other non-original chemicals adjust concentration according to data on the label of a chemical used.

Recommendation: Use the original ASEKO Pool & SPA chemicals

Warning: Higher concentrations of chemicals can result in shorter lifetime of ASIN AQUA Oxygen components and may cause injury and health damage.

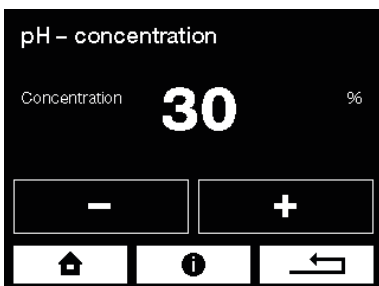

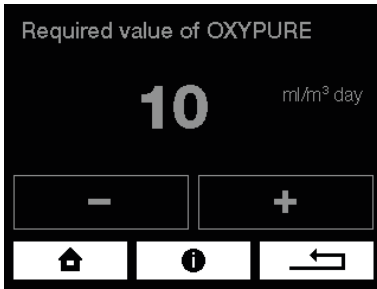

Values Required

OXY PURE Setting

A sufficiently effective dose for most pools is 10 ml/m³ per day. After several days in operation, measure OXYPURE concentration using the hand tester and change the dose, if required.

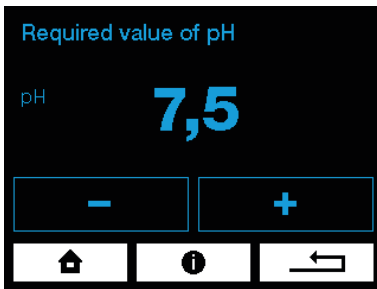

pH Setting

Considering that the ASIN AQUA Oxygen water treatment system is efficient in the broad pH range, it is useful to enter the required pH value equal to pH value of water you refill or slightly lower.

Required pH value = refilled water pH value

pH may change during operation but if it is in the range from 6.4 to 7.6, you do not have to change this setting.

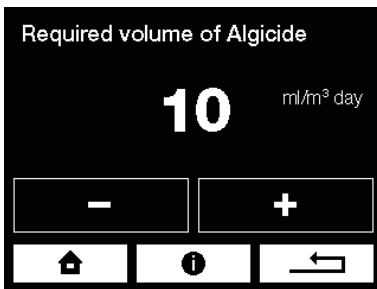

ALGICIDE Setting

A sufficiently effective dose for most pools is 10 ml/m³ per day. If green algae appear in the pool, you can increase the dose. After algae have disappeared, the dose can be returned to 10 ml.

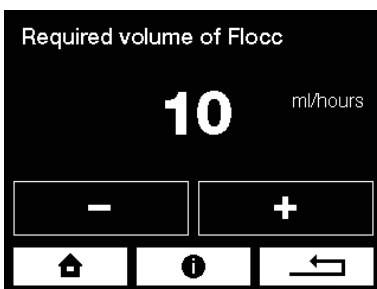

FLOC+C Setting

A FLOC+C dose follows the amount of circulating water flowing through the filter. Based on your circulating pump discharge (in m³ per hour), adjust the FLOC+C dose value. This value ranges from 5 to 20 ml per hour for most domestic pools.

Setting Values

Commissioning procedure

The water in the pool must be clean without any additives. Ideally fill the pool with fresh water from the water main.

1. Ensure the filtration system runs **NONSTOP** for 24 hours

- Set the required values via the main screen by pressing the appropriate tab (see the chapter Control):
- If you have the CLF probe, set the disinfection to 0.0 mg/l.
If you have the REDOX probe, set the disinfection to 000 mV.
- pH values leave at the factory setting for the time being (pH 7.0).
- Set ALGICID to 10 ml m³ per day (see the chapter ALGICID Setting).
- Set FLOC+C to 10 ml m³ per day (see the chapter FLOC+C Setting).

2. Close the water supply to the probes

ASIN AQUA Oxygen display “No water supply to the probes” notification.

3. Perform superchlorination

Perform superchlorination of pool water with Super CHLOR (inorganic active chlorine without stabilizers).

Follow the instructions on the packaging (1 kg = 80 m³).



Wait at least 1 hour. Optimally up to 24 hours.

If the **concentration is lower**, repeat superchlorination. If the **concentration is higher**, wait till the chlorine concentration in the water drop down.

4. Open the water supply to the probes

the “No water supply to the probes” notification will disappear from the ASIN AQUA Oxygen display.

5. pH adjustment

- Set the **required pH value** ideally close to the pH value of the incoming water.
- **ASIN AQUA Oxygen adjusts the pH automatically according to the preset required value.**
- **The ideal pH value** should be between **6.8 and 7.5**.

Initial dose:

After the pool installation or restart, dose a recommended initial dose of OXYPURE and ALGICIDE. In doing so, use the “Test of Outputs” screen which calculates a required dose according to your pool volume.

SHOCK DOSE

- If the pool water quality begins to deteriorate during operation, use the initial dose function for shock dosing of OXYPURE and ALGICIDE.

SuperCHLOR
#13120

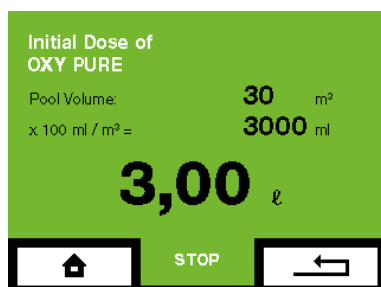
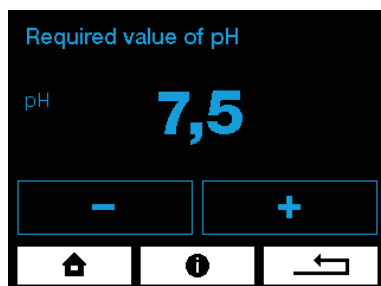

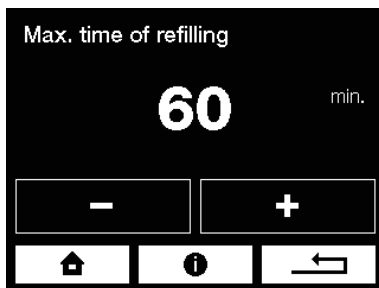
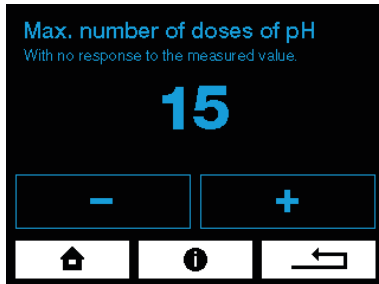
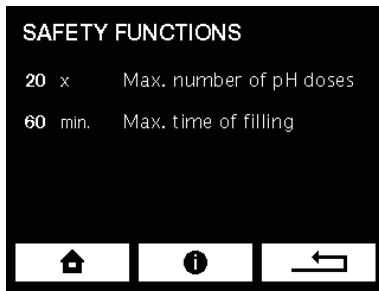

Safety Functions

Maximum Number of pH Doses - without Probe Response

If the measured pH value does not change even after preset quantity of doses (according to the settings), ASIN AQUA Oxygen stops pH dosing and an error message appears on the display.

The other ASIN AQUA Oxygen functions are not limited.

Maximum Refilling Time

The refilling of the pool is limited for the adjusted time.

In Operation Measurement and Calibration

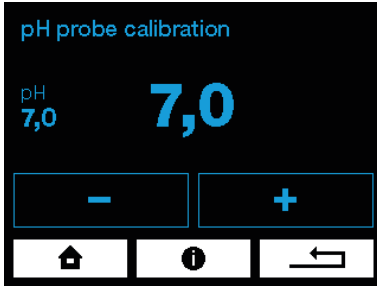

pH - Buffer 7,00 #12065



#12177 OX tester



pH Probe Calibration

When pH is being measured in operation, there may be a difference between the ASIN AQUA Oxygen value and the current pH value measured directly in water.

1. Remove the probe from ASIN AQUA Oxygen, leave the probe connected to Device by means of the cable.
Rinse the probe with clean water and wipe it.
Immerse the probe in the 7.0 calibration buffer and after stabilisation, enter this value into ASIN AQUA Oxygen on the pH Probe Calibration screen.
2. Measure pH value directly in the pool water by means of a photometer.
Then enter this value into ASIN AQUA Oxygen on the pH Probe Calibration screen.

Adjustment of OXYPURE Active Oxygen Dose

The optimum OXYPURE concentration value is from 50 to 100 mg.

From time to time check this value by means of the OX tester and adjust the dose in the menu, if required.

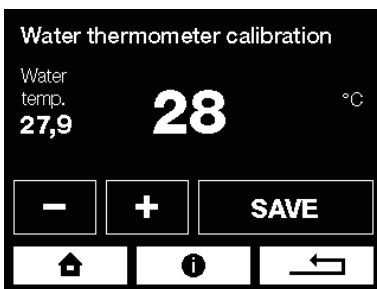

Water Thermometer Calibration

If water temperature is different from temperature shown by ASIN AQUA Oxygen, calibrate the thermometer in the water thermometer calibration menu.

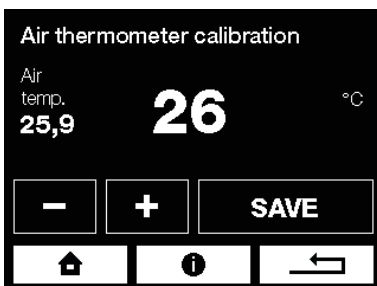

Air Thermometer Calibration

If air temperature is different from temperature shown by ASIN AQUA Oxygen, calibrate the thermometer in the air thermometer calibration menu.

In Operation Measurement and Calibration

Testing the pH probe

If the probe meet following qualifications, it can be used in the system and it is functional:

Probe has no visible mechanical damage.

Measured pH value is in tolerance $\pm 1,0$ (example - water pH is 7,2 and probe is measuring 7,9 - the tolerance is 0,7 so lower than 1,0 - the probe is OK)

Probe response to positive or negative changes in water or buffer. (example - if you dive the probe with dry and clean tip to 7,0 pH buffer the 1 minute response must be at least 90%)

If the probe meet all above qualifications and the ASIN AQUA Oxygen does not allow calibration it is necessary to upgrade the software to version with calibration range 7,0 $\pm 1,0$.

Internet Connection

The LAN connector is to be connected to the domestic router. Data are sent in the intervals of 10 seconds to the address **pool.aseko.com**, the route must not be blocked by the firewall.

Connection of ASIN AQUA Oxygen to your LAN is not complicated. You just need some basic IT skills. If you are not enough skilled to setup the connection by your own ask your IT specialist for help.

Possible Connection Methods

Home network

Connect the ASIN AQUA Oxygen to your router via LAN cable.

Mobile network

In case you have no direct internet access you can use the data transmission over the mobile network. Connect the ASIN AQUA Oxygen to your mobile network router via LAN cable.

Wifi connection

If you install the ASIN AQUA Oxygen in place where is no access to your private network by wired connection but your Wifi has enough signal, you can connect the ASIN AQUA Oxygen to your Wifi by use of Wifi extender.

Powerline via 230V/DC

If you have no wired access to your LAN network but your ASIN AQUA Oxygen is in the at the same electric network you can connect the LAN network via 230 V power line socket adapter.

If you have connection problems:

Please switch off ASIN AQUA.

Restart the router and switch on the ASIN AQUA again.

The home network must be open to communication on both sides for URL: **pool.aseko.com**



Connect LAN cable

Home network



3G / LTE



Wifi extender



Powerline
via 230 V
socket outlet

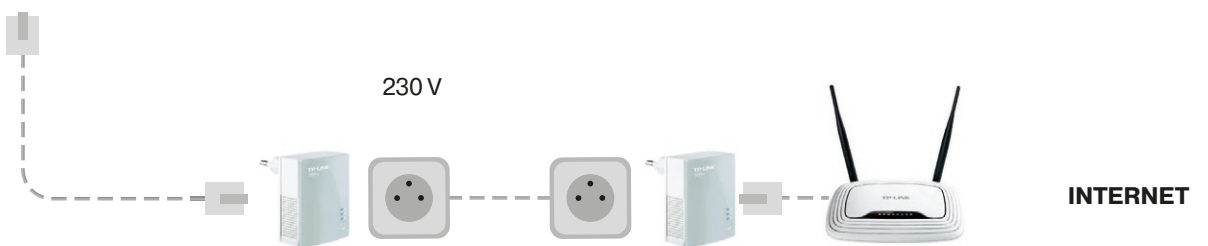

Aseko Web Services

Pool Live

The internet connection allows you to use the iPool Live mobile application and monitor your pool on mobile devices wheresoever the internet connection is available.

After you connect the ASIN AQUA Oxygen to the internet download the iPool Live application to your smartphone. Application is available for iOS and Android operation systems.

Main screen after opening will ask for typing your ASIN AQUA Oxygen serial number. If you have more pools equipped by the ASEKO NET adapter you can load all of them to one application.

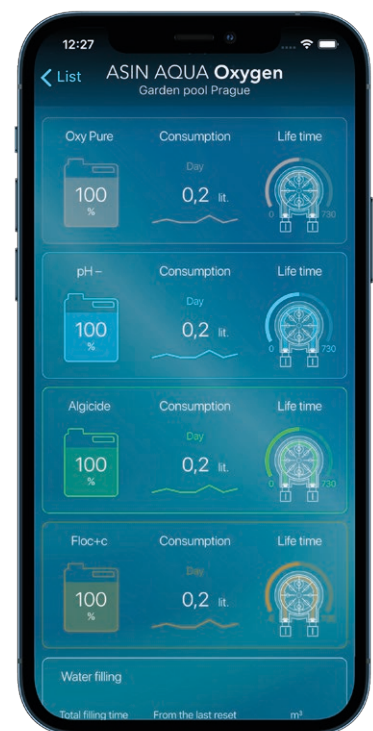
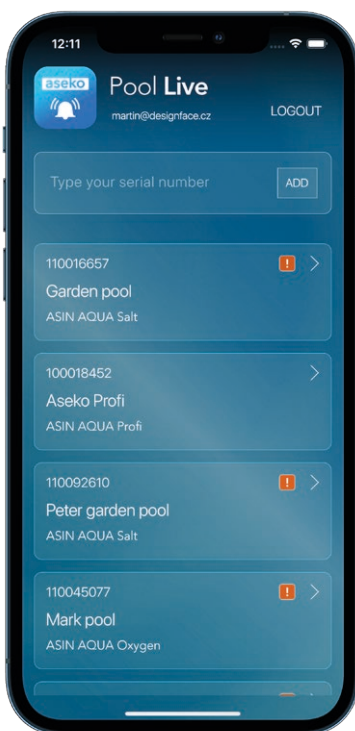

Pool LIVE
for iOS



Pool LIVE
for Android



<https://pool.aseko.com>

The web application for detailed monitoring of the pool water quality by means of well-arranged graphs. It shows all the measured parameters as well as ASIN AQUA Oxygen actions up to 30 days back.

This application is giving you the detailed information of the pool status and detailed review of all events, taken actions and act levels of monitored items up to 30 days back.

Transparent graphic environment of chart lines is giving fast report and you can easily see interconnection of monitored values.

This application is useful at public pool installations where you need to observe the history and monitor the pool water quality and maintenance. In case of any discrepancy in water quality you can find all actions, provided in that moment and in relation to other values you can diagnose the reason of such discrepancy.

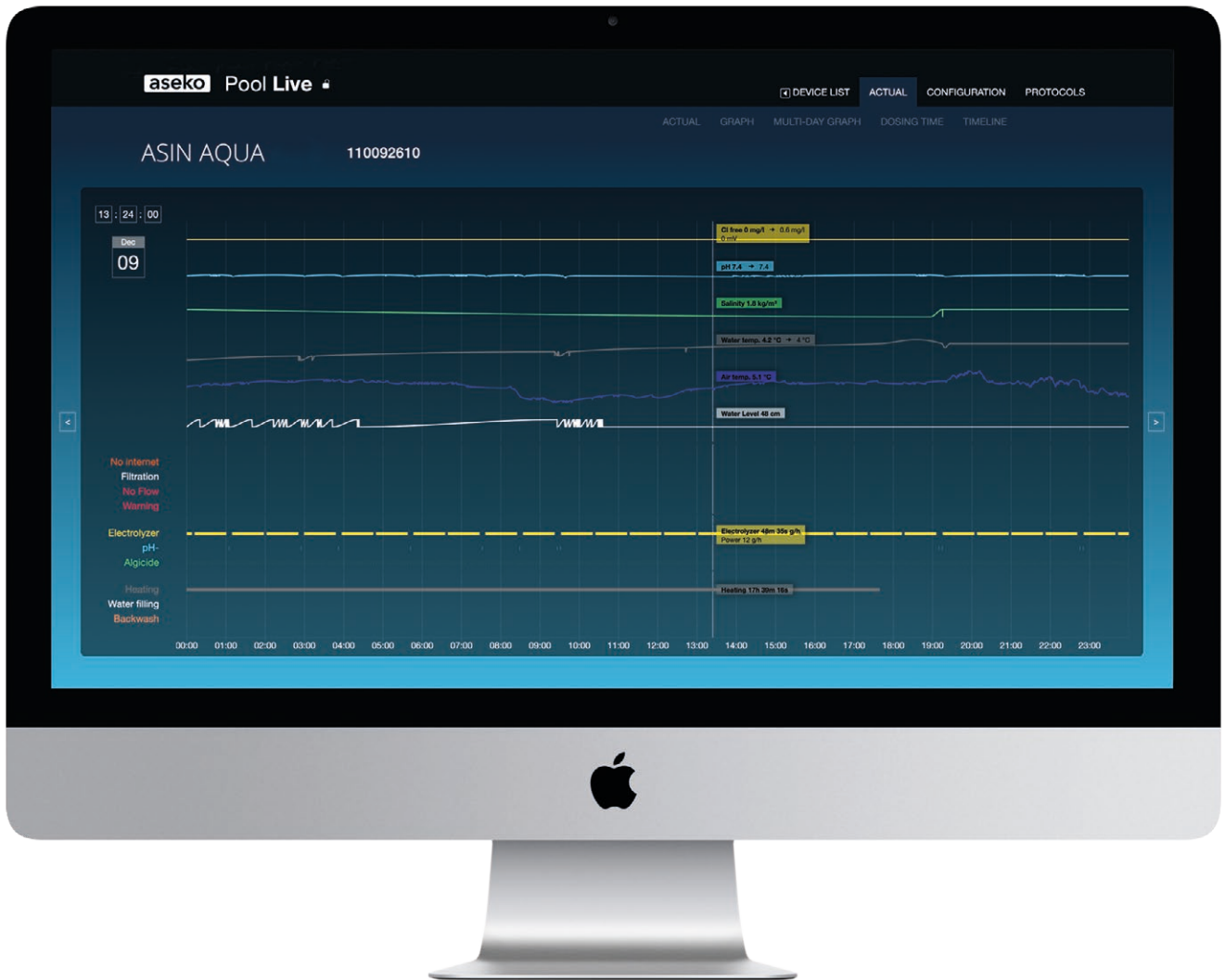

Maintenance

#12073 Replacement hose for the pump PP 60

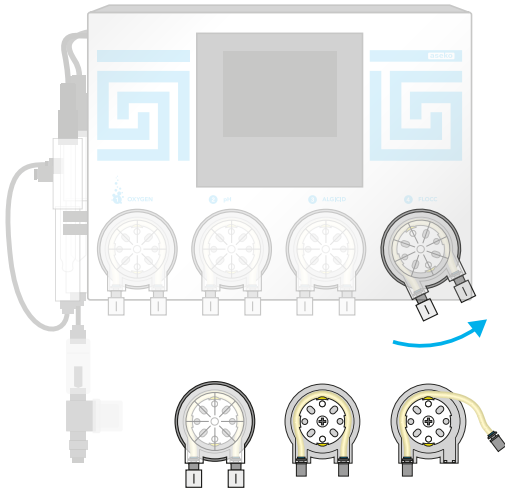

To ensure the optimum efficiency, perform visual checks and maintenance of ASIN AQUA Oxygen on a regular basis.

Pump Hose Replacement

To prevent the pump from failing, it is recommended to replace the hose #12073 every 24 months.

In doing so, proceed as follows:

- Switch off ASIN AQUA Oxygen.
- Turn the pump cover cassette anticlockwise and take it out of ASIN AQUA Oxygen.
- Release both hose ends and take it out of the cassette.
- Lubricate the new hose with the supplied special grease.
- Insert the lubricated hose into the cassette.
- Place the cover cassette back on ASIN AQUA Oxygen and turn it clockwise to lock it.
- Use new nuts, which are part of the replacement hose set, for connection of the PE tube.

#12005 Injection valve



#13087 Replacement rubber band for injection valve



#12012 pH probe



Injection Valve Maintenance

On a regular basis, check throughput of the injection valves, rubber band integrity, remove scale.

In case of private pools, replace injection valve rubber bands every 2 years. In case of public pools, replace #12005 every year.

pH Probe Maintenance

Take the pH probe out of ASIN AQUA Oxygen housing and clean it from impurities.

Follow the instructions attached to the used probe.

Error messages

Agent Run Out

- Check liquid levels on a regular basis, refill in time.

Dosing Pump does not Dose

- Leakage in connection of PE tubes or they are damaged.
- Failure of dosing pump. Check whether pump is running. If so, check the hose inside the pump for damage or breakage and replace it, if required.

Injection Valve Clogged

- Impassable spray valve.
Check the valve for being clogged with impurities or deposits or the rubber seal for being damaged.
- Failure of dosing pump. Check whether pump is running.
If so, check the hose inside the pump for damage or breakage and replace it, if required.

No Water Flow to Probe

- Check the measured water filter and clean it, if required.
- Check condition of connecting tubes from the extraction valve to the measured water inlet to probes and furthermore, from the water outlet from probes to the closing valve.
- Check condition of the extraction valve and the closing valve and their seals, for being clogged and their closed position.

Probe out of Service

- Measure pH using the hand tester. If the pH value is too low, a respective agent was overdosed due to an incorrect probe function (provided that other reasons given in the previous points have been excluded).
- Take the probe out and check it for mechanical damage.
- Clean the probe following the above procedure.
- It is recommended to replace the probes with the new probes every two years.

Too Rapid pH Change

Too rapid change of pH is usually caused by refilling water directly to the skimmer. If such rapid change of pH occur, ASIN AQUA Oxygen stops controlling pH for two hours.

This limitation can be manually disabled.

After pH has been stabilized or two hours have elapsed, ASIN AQUA Oxygen changes over to the normal mode.

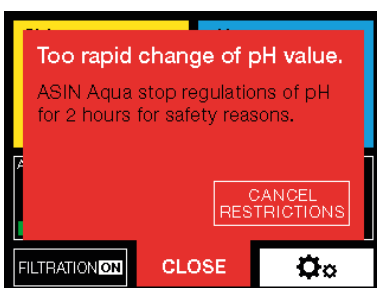
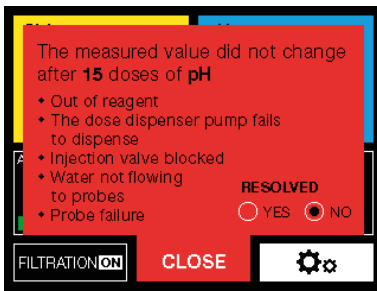

Externes Touchscreen Display



External
Touchscreen Display
#12048

The external display shows

1. Pool water parameters:
Temperature, pH value, redox potential or chlorine concentration.
2. Parameters of the air in the pool area:
relative humidity and temperature.

The setpoints can be set on the ASIN AQUA device and a probe calibration can be carried out via the external display.

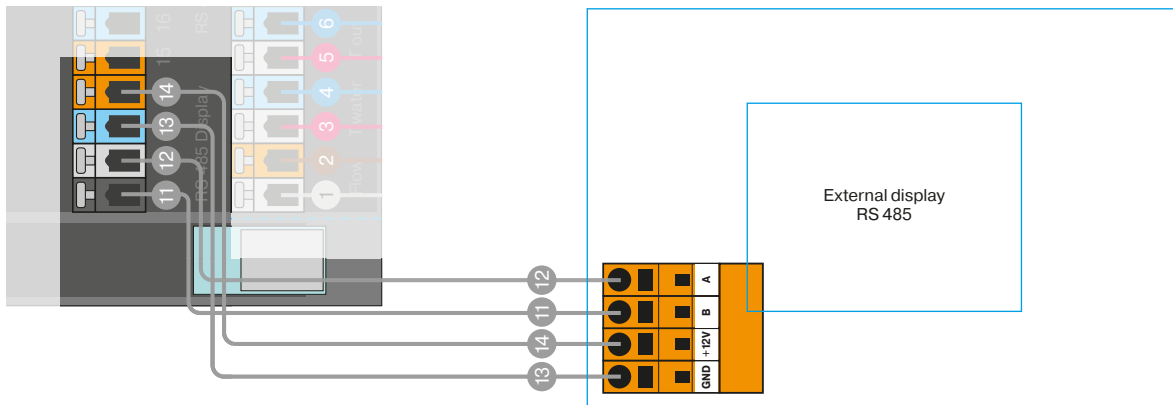

Enhancement of filtering efficiency



AFM® activated filter media

AFM is direct substitute for filter sand. It doubles efficiency of the existing filtration system. AFM® is resistant to biological pollution and formation of so-called bio-film.



ZPM® coagulation mixer

ZPM increases effects of coagulation and flocculation for transition of smaller dissolved solids (turbidity) to larger particles that can be removed by filtering.

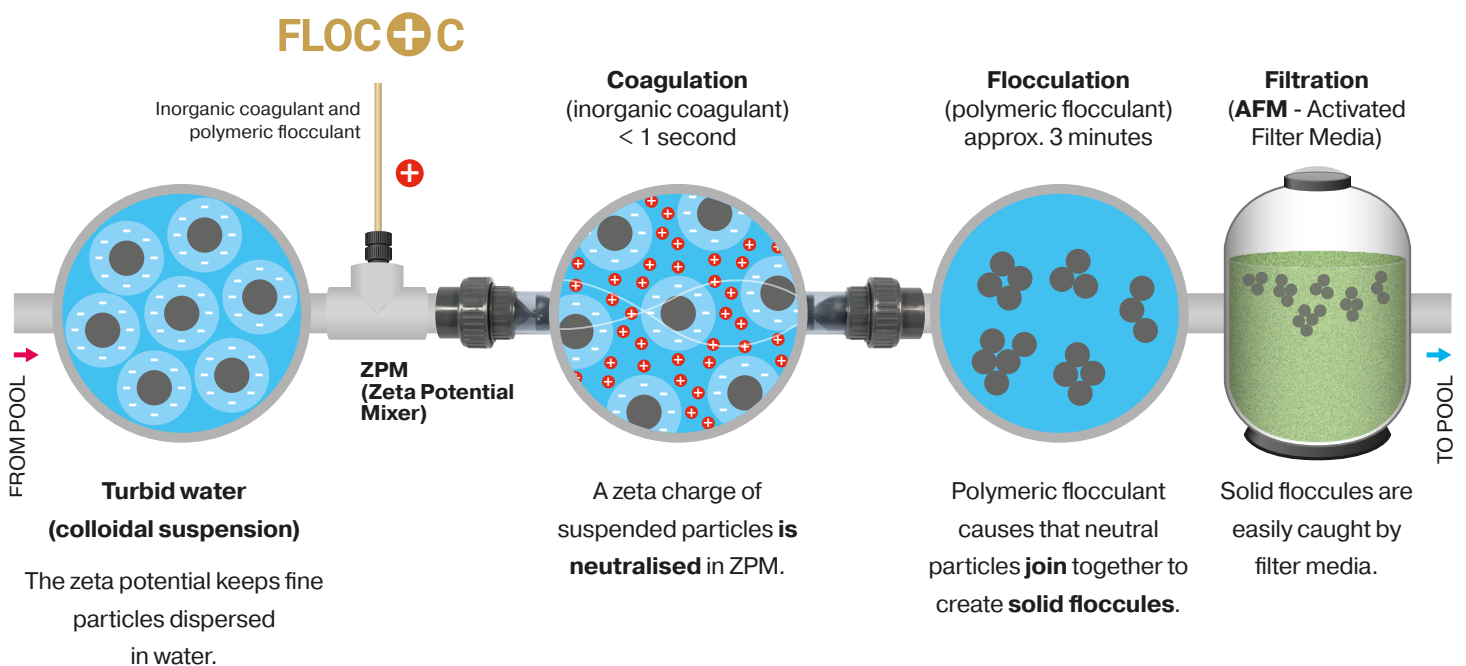



USER MANUAL

ASIN AQUA Oxygen VS

